

High Performance Molybdenum Glass Melting Electrodes



A Step ahead in Technology.



PLANSEE is the global market leader in powder metallurgically processed refractory and special metals. Working always with the most up-to-date technologies, we have been manufacturing products made from molybdenum, tungsten, tantalum, niobium, chromium and their alloys for more than 85 years. Our profound know-how regarding applications in the glass industry ensures we can provide our customers with the most innovative solutions.

PLANSEE is renowned for superior product-quality and performance. For the glass-production industry, we provide glass melting electrodes, homogenizing and gobbing stirrers with molybdenum core, molybdenum and tungsten nozzles for fiber production as well as new innovative products such as glass tank reinforcements for protection against corrosion. Our components are used in the most advanced glass making processes.

Electrical heating and boosting with PLANSEE molybdenum glass melting electrodes (GME) have set a new standard within the industry for efficiency in glass production:

- homogenous temperatures in the glass tank
- improved glass quality
- increased productivity
- higher flexibility regarding tonnage output
- environmentally-friendly production with reduced CO₂ emissions

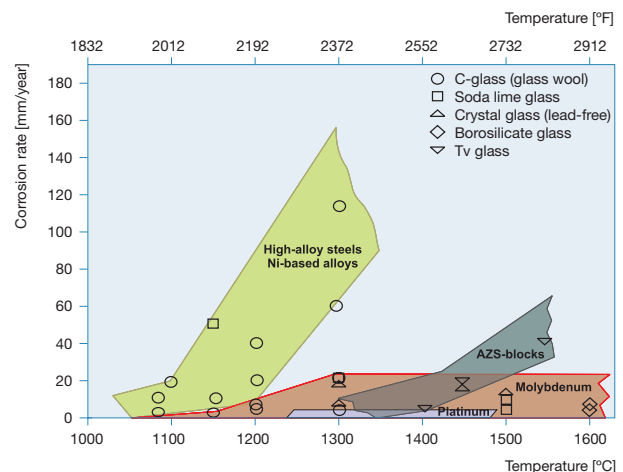

Molybdenum is characterized by its excellent corrosion-resistance to most glass melts. A low rate of material-loss is a decisive factor in lengthening the service-life of the electrode and particularly relevant for the glass quality.



Higher performance in the glass tank: PLANSEE molybdenum

Wherever operating temperatures and chemical requirements exceed the limits of conventional materials such as iron, copper, or nickel – molybdenum stands out with unique properties:

- high material strength at high temperatures
- good electrical conductivity
- excellent corrosion-resistance against molten glass

Physical properties of molybdenum

Testing temperature	20 °C / 68 °F	1000 °C / 1832 °F
Melting point [°C / °F]	2620 / 4748	
Density [g/cm ³]	10.2	-
Thermal conductivity [W/mK]	141	113
Specific electrical resistance [Ω mm ² /m]	0.056	0.315
Av. specific heat (20 °C / 68 °F to temp.) [J/kgK]	254	303
Av. linear thermal expansion (20 °C / 68 °F to temp.) [1/K]	5.15 x 10 ⁻⁶	5.84 x 10 ⁻⁶
Emissivity (ground surface)	0.06	0.16
Vapour pressure [mbar]	2.5 x 10 ⁻⁶ (1500 °C / 2732 °F)	
Young's modulus [GPa]	320	270

Our contribution to efficient glass melting

Whether you are manufacturing with fully or partially electrically-heated glass tanks or using an electrical boosting system, PLANSEE offers the ideal glass melting electrodes. High-quality glass production requires top performance from the glass melting electrodes. Whether you opt for standard or for customized dimensions and design, PLANSEE products will always provide you with:

- highest material purity
- optimized creep strength
- high corrosion-resistance
- guaranteed oxidation protection thanks to SIBOR® coating
- fast delivery from stock
- reliable and certified quality inspection
- customized finishing

Highest material purity

Our glass melting electrodes stand out by reason of their high purity. For molybdenum PLANSEE guarantees an overall purity of 99.97 %. In most cases the degree of purity is even higher (99.99 %). Traces of impurities such as carbon, nickel, and iron can lead to bubble formation or discoloration of the glass melt. PLANSEE sets up the manufacturing process with pure molybdenum oxide, without any recycled scrap. By manufacturing entirely in-house – from the conversion of oxide into metallic molybdenum powder, to pressing, sintering, deformation and finishing – PLANSEE guarantees the highest quality available.

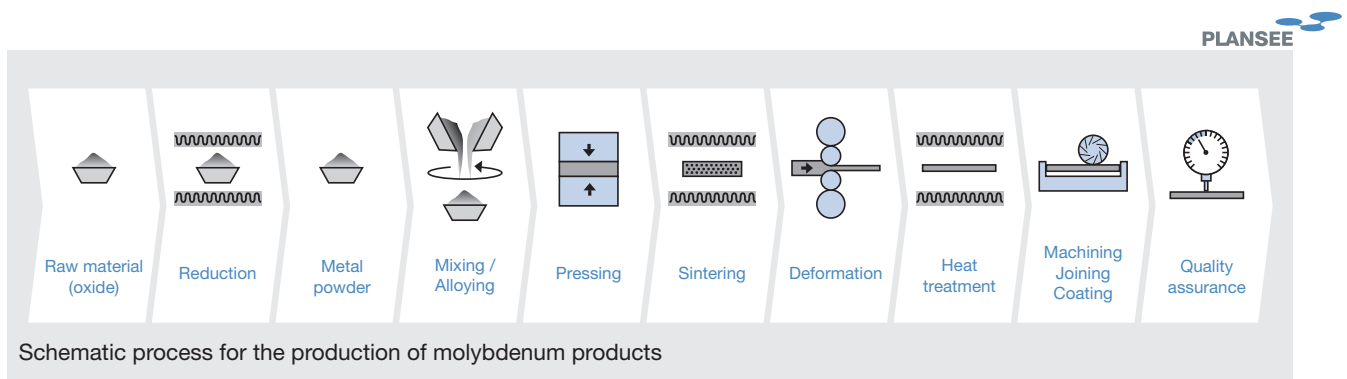

Chemical specification for molybdenum products		
Element	Guaranteed analysis max. [µg/g]	Typical analysis max. [µg/g]
Ag	10	< 5
Al	10	< 5
As	5	1
Ba	5	< 1
C	30	15
Ca	20	5
Cd	50	< 2
Co	20	3
Cr	20	3
Cu	20	5

Element	Guaranteed analysis max. [µg/g]	Typical analysis max. [µg/g]
Fe	60	30
H	10	3
K	10	3
Mg	10	< 5
Mn	2	< 1
N	5	< 2
Na	10	< 2
Nb	10	< 5
Ni	10	5
O	40	15

Element	Guaranteed analysis max. [µg/g]	Typical analysis max. [µg/g]
P	20	< 10
Pb	10	3
S	10	< 2
Si	30	5
Ta	20	< 10
Ti	10	2
W	250	100
Zn	10	< 5
Zr	10	< 2
Mo	min. 99.7 %*	99.99 %*

*) Metallic purity without tungsten

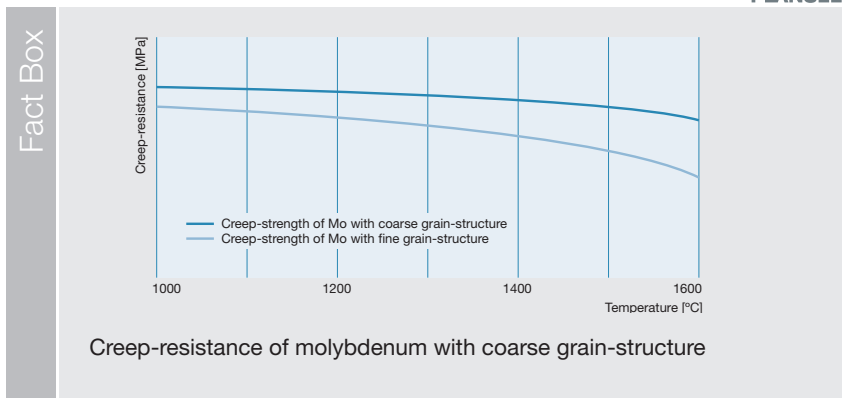

Optimized creep strength

The coarse grain structure of PLANSEE electrodes results in higher creep-resistance. PLANSEE electrodes minimize any bending during operation, which leads to higher efficiency, less corrosion of the surroundings and less wear of the electrode. Moreover less bending minimizes the danger of any contact of the glass melting electrode and its holder.

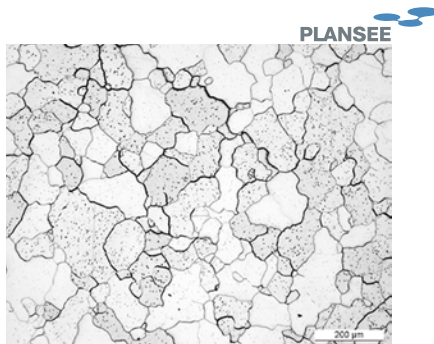

Coarse grain-structure for best creep-resistance

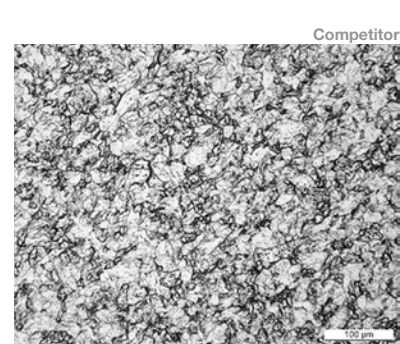

Fine grain-structure with low creep-resistance

High corrosion resistance

PLANSEE operates the world's largest hammer forging machine for refractory metals. With a force of more than 20 t/cm² the glass melting electrodes are forged to final dimensions with very tight dimensional and surface tolerances. Since no additional machining is required, this results in completely closed grain-boundaries and an extremely dense surface condition, which leads in turn to unrivalled corrosion-resistance.



Hammer forging machine

*PLANSEE SIBOR® coating.
Guaranteed protection.*

- SIBOR® guarantees protection during the up-tempering process
- SIBOR® simplifies the installation in the glass tank which eliminates potential danger for the operators
- SIBOR® opens up new possibilities of using plate or block electrodes to heighten the performance of the glass tank
- SIBOR®-coated electrodes are easy to handle

Guaranteed oxidation-protection through SIBOR® coating

Above 400 °C / 752 °F molybdenum starts to react with air, forming MoO₃, which sublimates at higher temperatures as yellow smoke. During the up-tempering of the glass tank the new PLANSEE SIBOR® coating reliably protects the electrodes against any oxidation. SIBOR® adheres inseparably to the molybdenum by building a diffusion zone on the molybdenum surface. SIBOR®-coated electrodes or glass tank reinforcement can easily be installed in a new or rebuilt tank. For further applications of SIBOR® coating please refer to our SIBOR® brochure.

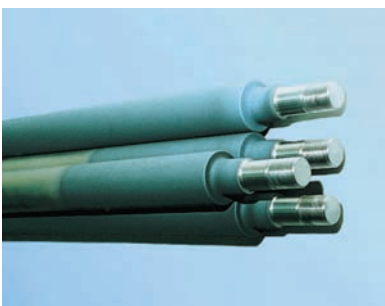

Glass melting electrodes with SIBOR® coating

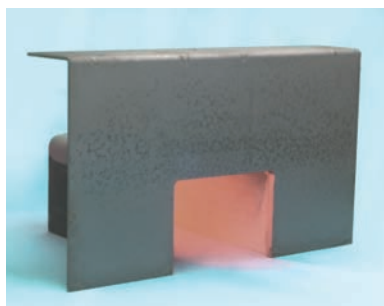

Molybdenum throat channel protection fully coated with SIBOR®

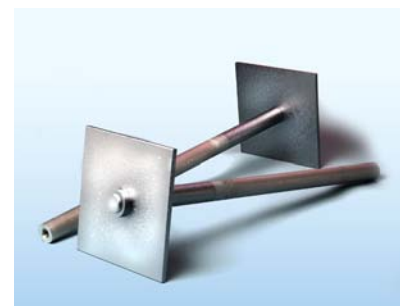

SIBOR®-coated Molybdenum plate electrode

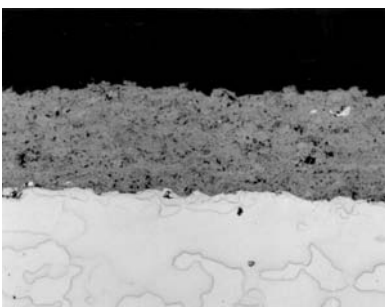

Micrograph of a cross-section of as-coated SIBOR®, thickness 150 µm

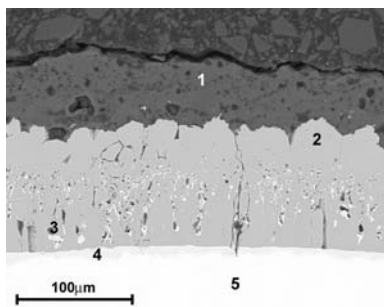

SEM (BS-mode) of a heat-treated SIBOR® coating; EDX: 1 - Si (molten SIBOR®); 2 - Si, 4 - Mo, (Si); 3, 5 - Mo

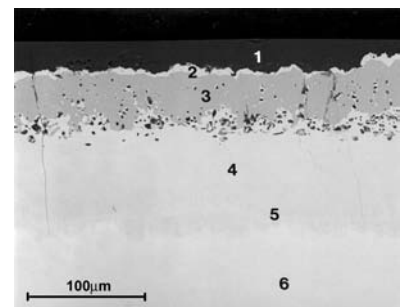

SEM (BS-mode) cross-section of an oxidized SIBOR®-coated Mo-sample (168 h in air at 1450°C). EDX: 1 - SiO₂; 2 - Mo, Si; 3 - Si, Mo; 4 - Mo, Si, B; 5 - Mo, (Si); 6 - Mo

Fast delivery from stock

All standard dimensions of glass melting electrodes are available directly from stock via PLANSEE Express. The diameters from the list below are all delivered in our special smooth-forged surface-quality with stated straightness. Metric, tapered or customer-specific threadings are available in two to three weeks. The table below shows the recommended standardized metric and tapered threads for the respective electrode diameters in order to guarantee optimal mechanical and electrical properties when in use.

Standard dimensions and thread types for glass melting electrodes										
Diameter [mm]	Diameter [inch]	Production lengths [mm] (tolerance: ≤ 1000 = ±5% > 1000 = ±50mm)	Straightness per m [mm]	Diameter tolerance (forged surface)	Average weight [kg/m]	Typical threads				
						Cylindrical			Tapered	
31.75	1.25	2000	< 2.0	± 0.3	8.1	M22 x 1.5	M18 x 1.5	7/8 - 14 UNF	1 - 8 UNC 3.00 T/ft.	
48		3000	< 1.5	± 0.3	18.5	M24 x 1.5	M22 x 1.5	7/8 - 14 UNF		
50.8	2	2000	< 1.0	+ 0 / - 0.8	20.7	M27 x 3	M24 x 1.5	1 1/4 - 12 UNF	1 9/16 - 8 UN 3.00 T/ft.	
54		2000	< 1.0	± 0.4	23.4	M36 x 3	M27 x 3	1 1/4 - 12 UNF		
60		2000	< 1.0	± 0.4	28.8	M36 x 3	M27 x 3	1 1/4 - 12 UNF		
63.5	2.5	2000	< 1.0	± 0.4	32.3	M36 x 3		1 1/4 - 12 UNF	1 9/16 - 8 UN 3.00 T/ft.	1 15/16 - 8 UN 3.00 T/ft
70		2000	< 2.5	± 1.0	39.3	M42 x 3		1 1/2 - 12 UNF		
76.2	3	2000	< 2.5	± 1.0	46.5	M42 x 3		1 1/2 - 12 UNF	1 15/16 - 8 UN 3.00 T/ft	2 3/8 - 6 UN 3.00 T/ft
80		2000	< 2.5	± 1.0	51.3	M42 x 3		1 1/2 - 12 UNF		
90		2000	< 2.5	± 1.0	64.9	M58 x 3		2 1/4 - 8 UNF		
101.2	4	2000	< 2.5	± 1.0	82.0	M58 x 3		2 1/4 - 8 UNF	2 3/8 - 6 UN 3.00 T/ft	3 - 6 UN 3.00 T/ft

Special thread dimensions according to our customers' specifications, as well as different length and diameter tolerances are available. Quotations and delivery times on request.



Reliable and certified quality inspection

To guarantee top performance our inspection routines include chemical analysis and dimensional control of threading, diameter, straightness, and length. Additionally, each electrode is ultrasonically tested to detect even the smallest cracks and to minimize the risk of breaking.

Our company is certified according to ISO 9001. Moreover, we are capable of carrying out chemical analyses as well as investigations of physical properties in our authorized and certified laboratories in accordance with customers' requests.

Customized finishing

PLANSEE offers customer-specific threadings, cooling drills, and customized coatings such as NICROM[®], a steam-resistant inside coating to minimize steam boiling corrosion.

Different electrode designs, such as block and plate electrodes in various dimensions, can be manufactured. These designs are available with or without SIBOR[®] coating for oxidation-protection during up-tempering of the glass tank.



Quality inspection for glass melting electrodes:

Ultra-sonic testing



Straightness



Threading

Over the years, PLANSEE has gained considerable insight into factors critical for success in the glass industry. With profound application know-how we strengthen our customer's competitiveness and improve performance levels. For the correct operation of molybdenum glass melting electrodes please take careful note of the following information.

No lubricants in threadings

Lubricants are not necessary for the connection of standard threads. If connected properly, the threads will not jam and the shoulders will fit precisely. Depending on their type and composition, lubricants can even cause problems. Organic lubricants burn at high temperatures and the carbon released in this process can diffuse into the molybdenum. For applications in the field of the glass industry only small amounts of carbon impurities are permissible, as carbon can cause CO and CO₂ bubbles to form. Furthermore, lubricants can have an insulating effect which hinders the flow of current.

Connection via shoulder contact

To ensure optimum flow of current, the glass melting electrodes have to be connected via shoulder contact. The shoulder and threading of the electrodes have to be free of any cracks, scratches and marks to ensure a tight contact. PLANSEE has adapted the design of tapered threads to guarantee tight contact as shown below:

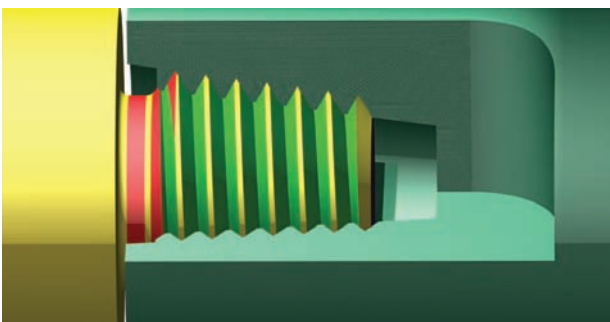

Standard tapered thread without shoulder contact.

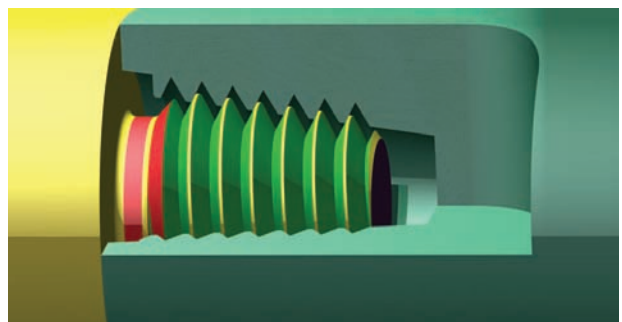

Tapered thread with shoulder contact for a glass melting electrode application

Threading recommendations

Length and diameter of the threading have to be adapted on the diameter of the electrode. The threading has to absorb the bending strength of the electrode. General rule is that the diameter of the threading should be approximately 20 mm less than the diameter of the electrode to ensure a large sufficient contact. The length and diameter of the threading should be approximately equal.

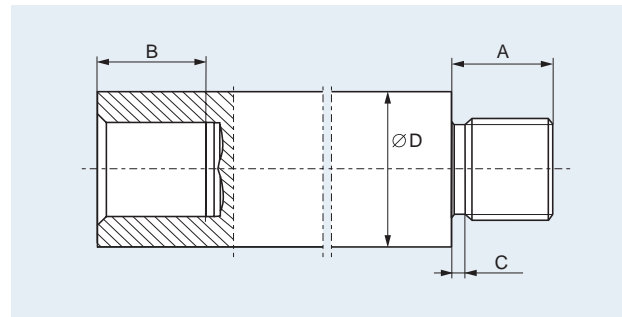

Recommended PLANSEE standard threadings are.

Recommended cylindrical thread design for glass melting electrodes							
Metric threads				UN threads			
Thread	Length of male thread A [mm]	Depth of female thread B [mm]	Chamfer C [mm]	Thread	Length of male thread A [mm]	Depth of female thread B [mm]	Chamfer C [mm]
M 18 x 1.5	20.5	22.5	1.5	7/8 - 14 UNF	25.5	27.5	2.0
M 22 x 1.5	24.5	26.5	1.5	1 1/4 - 12 UNF	29.0	31.0	2.5
M 24 x 1.5	26.5	28.5	1.5	1 1/2 - 12 UNF	34.0	36.0	2.5
M 27 x 3	31.5	33.5	3.0	2 1/4 - 8 UNF	51.0	53.0	3.5
M 36 x 3	33.5	35.5	3.0				
M 42 x 3	38.5	40.5	3.0				
M 58 x 3	51.0	53.0	3.0				

Regarding bending strength tapered threads are in general less favourable than metric threads.

Turning of the electrode at regular intervals

The flow of the glass around the electrodes leads to an ununiform wear, mainly this causes an elliptical cross section by erosion processes. This elliptical shape has much less creep-resistance than round shaped electrodes and the bending leads to a breaking of the electrode. This mechanism of becoming elliptical can be avoid by turning the electrode in regular intervals. To prevent the threads from becoming loose during turning process the electrodes have to be turned in a clockwise direction only.

Sealing by glassification

For the installation of the electrode it is recommended to first push it into the glass melt and then pull it back into the electrode holder, while turning it continuously in a clockwise direction. Through cooling of the electrode holder, the glass layer solidifies, thus providing protection against diffusion. Before inserting an extension electrode, the cooling of the holder should be slightly reduced so as to promote melting of the solidified glass layer.

Sufficient cooling

Sufficient cooling of the electrode holder is of the utmost importance. At high temperatures certain atoms – e.g. iron and nickel atoms – diffuse out of the electrode holder into the molybdenum of the electrode, forming brittle and low-melting phases. In order to avoid such problems the electrode holder, and consequently the glass melting electrode as well, must be cooled sufficiently, and the electrode must be completely immersed in the glass melt. Otherwise, there can occur a melting of the solidified glass layer in the gap, and this can in turn affect the atom-diffusion process described above, by bringing about a direct contact between the glass melting electrode and its holder. Frequent monitoring of the electrical values is important in order to ensure punctual replenishment and thus avoid overheating. In addition, electrode-erosion is influenced by temperature: high temperatures result in increased electrode-erosion and thus in reduced service-life.

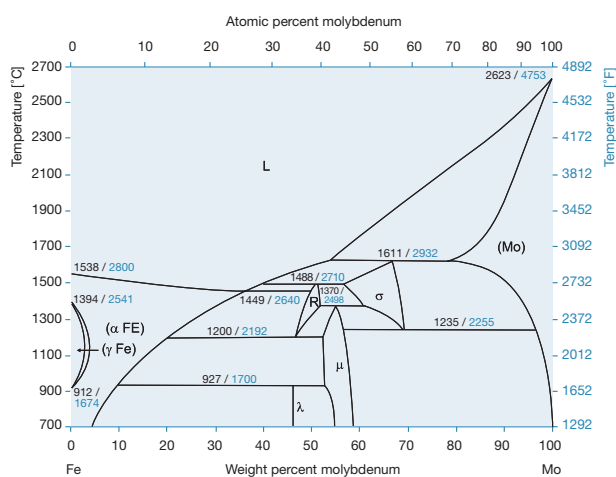

Binary phase diagram of Mo/Fe

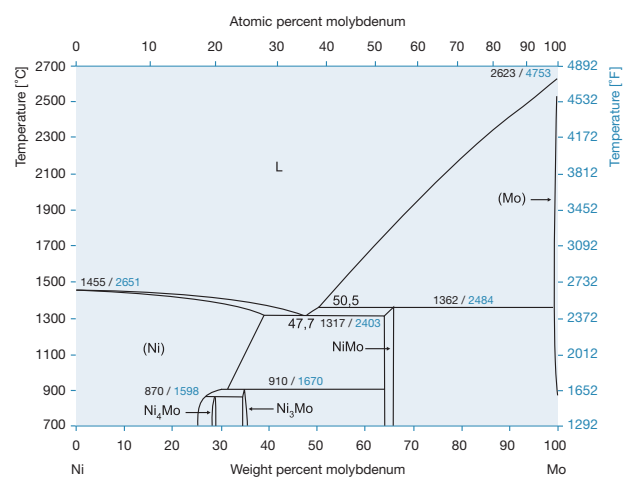

Binary phase diagram of Mo/Ni

Reducing the current surface-density

A current surface-density of 1 to maximum 2 A/cm² is acceptable for glass melting electrodes. Corrosion increases drastically in step with increasing surface current-density. A good possibility to minimize this strain is to increase the surface itself by choosing a greater diameter or changing, especially in the feeder section, to plate or block electrodes.

Operating length

The operating length of the electrode is another decisive factor regarding the service life. The longer the operating electrode, the higher the danger of bending. On the contrary, if the operating length becomes too short, higher corrosion of the bricks in the surrounding of the electrode occurs and also an overheating of the electrode holder can be caused.

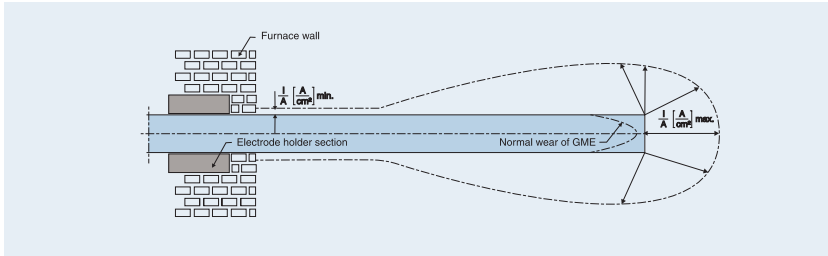

Correct surface current-density distribution with sufficient immersion

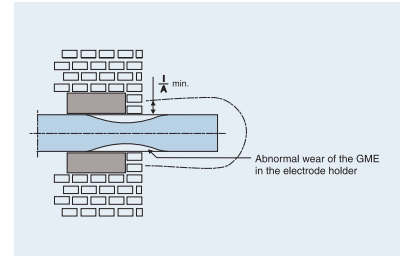

Incorrect surface current-density distribution with insufficient immersion

Formulae for length and diameter calculation for glass melting electrodes

$A_{\text{active}} = \frac{I}{J}$	A_{active} [cm ²]	calculated active electrode area in the tank
	I [A]	necessary current per electrode
	J [A/cm ²]	chosen surface current density (recommended: 1A/cm ² , max. 2A/cm ²)
$V = \frac{l_{\text{active}}}{\varnothing} = 12 - 16$	V []	Ratio of active length to electrode diameter (recommended: 12 to 16) [according to Glenn J. Conger, Owens Illinois Inc. Toledo, Ohio]
	\varnothing [cm]	electrode diameter
$l_{\text{active}} = V \cdot \varnothing$	l_{active} [cm]	active electrode length in the tank

Choice of refining agent

The refining agent and its concentration in the glass melt have a large influence on the total corrosion of the electrode. Minimizing the concentration or changing to a less corrosive system can increase the service life of the molybdenum significantly.

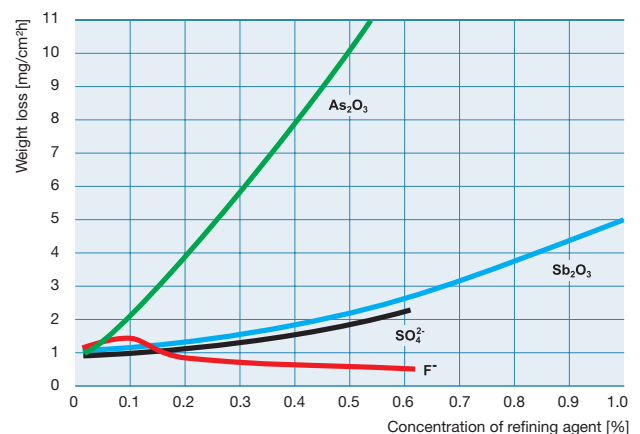

Material consumption due to refining agents (J. Vach and V. Süsser: Schmelzen von Gläsern in kleinen elektrischen Öfen, 46. Glastechnische Tagung, Wiesbaden, 1972)

Parent Company

Austria
PLANSEE SE
E-mail: info@plansee.com
www.plansee.com

Production Refractory Metals

Austria
PLANSEE Metall GmbH
E-mail: info@plansee.com

Werk Liezen
E-mail: liezen@plansee.com

Japan
PLANSEE Japan Ltd.
E-mail: tokyo@plansee.com

PLANSEE Bondingshop K.K.
E-mail: japan@pbkk.co.jp

USA
E/G Electro-Graph, Inc.
E-mail: sales@egraph.com

PLANSEE USA LLC.
E-mail: usa@plansee.com

Production Composite Materials

France
PLANSEE Tungsten Alloys
E-mail: plansee-ta@plansee.com

Germany
PLANSEE Composite Materials GmbH
E-mail: plansee-cm@plansee.com

Switzerland
PLANSEE Powertech AG
E-mail: powertech@plansee.com

www.plansee.com

Sales Subsidiaries

Austria
PLANSEE Metall GmbH
E-mail: info@plansee.com

Baltic States (Estonia, Latvia, Lithuania)
PLANSEE Nordic AB
E-mail: info@plansee.se

Brasil
PLANSEE South America Ltda
E-mail: plansee@plansee.com.br

Canada
PLANSEE USA LLC.
E-mail: usa@plansee.com

China
PLANSEE China Ltd.
E-mail: info@plansee.cn

PLANSEE Beijing Office
E-mail: info@plansee.cn

PLANSEE Shanghai Commercial Ltd.
E-mail: info@plansee.cn

Czech Republic
PLANSEE SE
E-mail: cz@plansee.com

France
PLANSEE SE Succursale Française
E-mail: plansee.france@plansee.com

Germany
PLANSEE SE Vertriebsniederlassung Deutschland
E-mail: plansee.deutschland@plansee.com

Great Britain
PLANSEE SE Sales Office UK
E-mail: uk@plansee.com

India
PLANSEE SE Liaison Office India
New Delhi Office
E-mail: delhi@plansee.com

Bangalore Office India
E-mail: bangalore@plansee.com

Israel
PLANSEE SE
E-mail: israel@plansee.com

Italy
PLANSEE SE Sales Office Italy
E-mail: italy@plansee.com

Japan
PLANSEE Japan Ltd.
Tokyo Office
E-mail: tokyo@plansee.com

Osaka Office
E-mail: osaka@plansee.com

Korea
PLANSEE Korea Co., Ltd.
E-mail: service@plansee.co.kr

Mexico
PLANSEE Mexico S.A. de C.V.
E-mail: mexico@plansee.com

Netherlands
PLANSEE Nederland
E-mail: verkoop@plansee.com

**Scandinavia
(Norway, Sweden, Finland)**
PLANSEE Nordic AB
E-mail: info@plansee.se

Slovak Republic
PLANSEE SE
E-mail: slovakia@plansee.com

Spain
PLANSEE SE
E-mail: spain@plansee.com

Taiwan
PLANSEE Taiwan Co. Ltd.
E-mail: service@plansee.com.tw

USA
PLANSEE USA LLC.
E-mail: usa@plansee.com

E/G Electro-Graph, Inc.
E-mail: sales@egraph.com

Sales Partners and Distributors

Australia, Argentina, Belgium, Denmark, Egypt,
Israel, Malaysia, Singapore, Pakistan, Poland,
South Africa, Thailand, Turkey

A Step ahead in Technology.

PLANSEE